

# PROTECTIVE TUBE SYSTEM

## Protecting tube

model no.	diameter (Ø) mm	length (A) mm	EAN code	Weight per 100 m kg	smallest PU
<b>F</b> MI 30/6 F	30	6000	906901	113,3	1 x 6 m
<b>E3</b> MI 30/6 E3	30	6000	908103	113,3	1 x 6 m

30

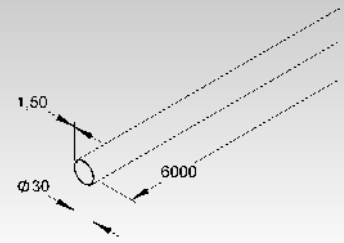

## Joiner/coupler

model no.	diameter (Ø) mm	EAN code	Weight per 100 pce. kg	smallest PU
<b>F</b> MIK 30 F	30	906987	12	1 St.
<b>E3</b> MIK 30 E3	30	908189	12	1 St.

30

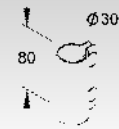

## Joiner/coupler

slotted

model no.	diameter (Ø) mm	EAN code	Weight per 100 pce. kg	smallest PU
<b>F</b> MIKG 30 F	30	907007	17	1 St.
<b>E3</b> MIKG 30 E3	30	908202	17	1 St.

30

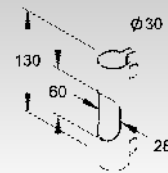

## Protecting tube bend 45°

model no.	diameter (Ø) mm	EAN code	Weight per 100 pce. kg	smallest PU
<b>F</b> MIB 3045 F	30	906925	35	1 St.
<b>E3</b> MIB 3045 E3	30	908127	35	1 St.

30

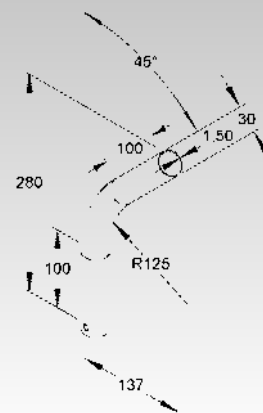

## Protecting tube bend 90°

model no.	diameter (Ø) mm	EAN code	Weight per 100 pce. kg	smallest PU
<b>F</b> MIB 3090 F	30	906949	48	1 St.
<b>E3</b> MIB 3090 E3	30	908141	48	1 St.

30

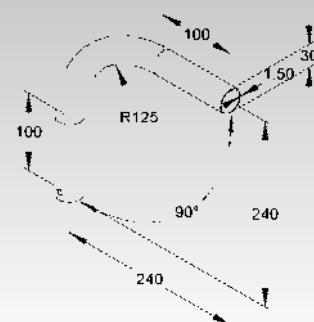

### Protecting tube tee

model no.	diameter (Ø) mm	EAN code	Weight per 100 pce. kg	smallest PU
<b>F</b> MIT 3090 F	30	906963	67	1 St.
<b>E3</b> MIT 3090 E3	30	908165	67	1 St.

30

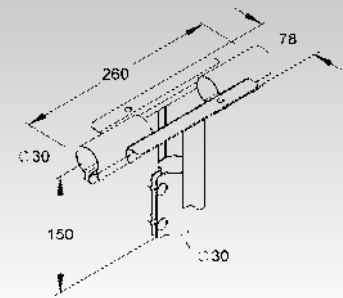

### Protecting tube floor fixing

model no.	diameter (Ø) mm	thickness (t) mm	EAN code	Weight per 100 pce. kg	smallest PU
<b>F</b> MIAB 30 F	30	5	907021	36	1 St.
<b>E3</b> MIAB 30 E3	30	4	908226	36	1 St.

30

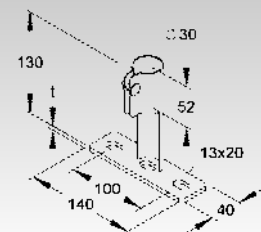

### Protecting tube floor fixing

model no.	diameter (Ø) mm	EAN code	Weight per 100 pce. kg	smallest PU
<b>F</b> MIABR 30 F	30	907045	48	1 St.
<b>E3</b> MIABR 30 E3	30	908240	48	1 St.

for mounting with tube clamp

30

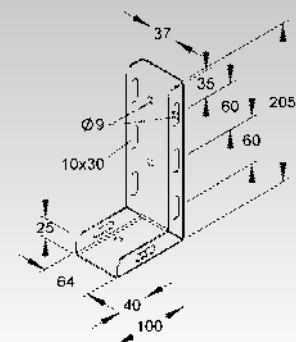

### Protecting tube support with bracket

model no.	diameter (Ø) mm	EAN code	Weight per 100 pce. kg	smallest PU
<b>F</b> MIHR 3015 F	30	907106	55	1 St.
<b>E3</b> MIHR 3015 E3	30	908301	55	1 St.

for mounting to cable tray or cable ladder

30

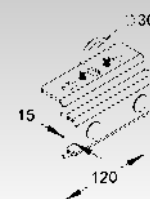

### Protecting tube support with bracket

with joiner/coupler

model no.	diameter (Ø) mm	EAN code	Weight per 100 pce. kg	smallest PU
<b>F</b> MIHK 3015 F	30	907120	131	1 St.
<b>E3</b> MIHK 3015 E3	30	908325	131	1 St.

for mounting to cable tray or cable ladder

30

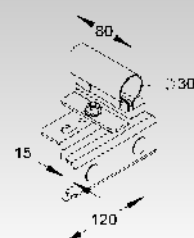

# PROTECTIVE TUBE SYSTEM

## Protecting tube support with bracket

model no.	diameter (Ø) mm	EAN code	Weight per 100 pce. kg	smallest PU
<b>F</b> MIHR 3030 F	30	907144	64	1 St.
<b>E3</b> MIHR 3030 E3	30	908349	64	1 St.

for mounting to wide span cable tray or wide span ladder

30

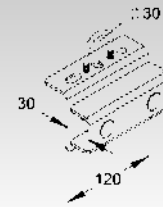

## Protecting tube support with bracket

with joiner/coupler

model no.	diameter (Ø) mm	EAN code	Weight per 100 pce. kg	smallest PU
<b>F</b> MIHK 3030 F	30	907168	141	1 St.
<b>E3</b> MIHK 3030 E3	30	908363	141	1 St.

for mounting to wide span cable tray or wide span ladder

30

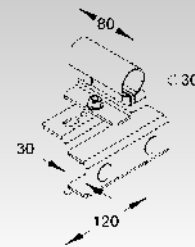

## Protecting tube support with bracket

model no.	diameter (Ø) mm	EAN code	Weight per 100 pce. kg	smallest PU
<b>F</b> MIHR 30 F	30	907182	88	1 St.
<b>E3</b> MIHR 30 E3	30	908387	88	1 St.

for mounting to allround cable ladder

30

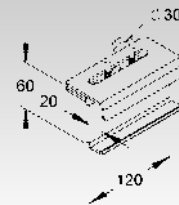

## Protecting tube support with bracket

with joiner/coupler

model no.	diameter (Ø) mm	EAN code	Weight per 100 pce. kg	smallest PU
<b>F</b> MIHK 30 F	30	907205	80	1 St.
<b>E3</b> MIHK 30 E3	30	908400	80	1 St.

for mounting to allround cable ladder

30

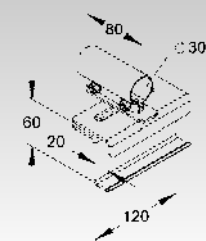

## Protecting tube mounting plate

incl. 1 endless screw clamp

model no.	height (H) mm	diameter (Ø) mm	EAN code	Weight per 100 pce. kg	smallest PU
<b>F</b> MIMPA 30/175 F	175	30	907069	69	1 St.
<b>E3</b> MIMPA 30/175E3	175	30	908264	69	1 St.

30

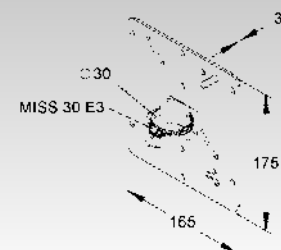

## Protecting tube mounting plate

incl. 2 endless screw clamps

model no.	height (H) mm	diameter (Ø) mm	EAN code	Weight per 100 pce. kg	smallest PU
<b>F</b> MIMPA 30/260 F	260	30	907083	113	1 St.
<b>E3</b> MIMPA 30/260E3	260	30	908288	113	1 St.

30

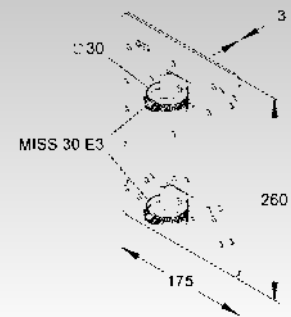

## Protecting tube clamp

model no.	diameter (Ø) mm	EAN code	Weight per 100 pce. kg	smallest PU
<b>F</b> MIRS 30 F	30	907229	6	20 St.
<b>E3</b> MIRS 30 E3	30	908424	6	20 St.

30

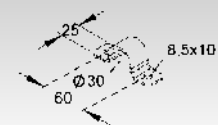

## Drill distance clamp

heavy

model no.	diameter (Ø) mm	EAN code	Weight per 100 pce. kg	smallest PU
<b>F</b> SASS 30 F	30	907236	10	1 St.
<b>E3</b> SASS 30 E3	30	908431	10	20 St.

30



## Tube clamp

model no.	diameter (Ø) mm	EAN code	Weight per 100 pce. kg	smallest PU
<b>F</b> MIRB 30 F	30	907243	3	20 St.
<b>E3</b> MIRB 30 E3	30	908448	3	20 St.

30



## Protecting tube anchor clamp

incl. 1 endless screwed clamp

model no.	diameter (Ø) mm	EAN code	Weight per 100 pce. kg	smallest PU
<b>F</b> MIMS 30 F	30	907267	8	1 St.
<b>E3</b> MIMS 30 E3	30	908462	8	1 St.

30

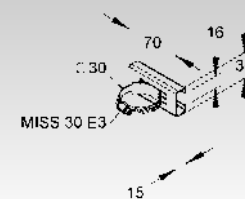

## Endless screw clamp

model no.	diameter (Ø) mm	EAN code	Weight per 100 pce. kg	smallest PU
<b>E3</b> MISS 30 E3	30	908486	2	50 St.

30

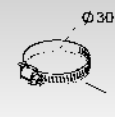

# PROTECTIVE TUBE SYSTEM

## Protective endcap, soft plastic

model no.	diameter (Ø) mm	color	EAN code	Weight per 100 pce. kg	smallest PU
K10 SKMI 30	30	yellow	907281	1	25 St.

To prevent accidents and injuries you must install protective end caps.

30



## Protective endring, soft plastic

model no.	diameter (Ø) mm	color	EAN code	Weight per 100 pce. kg	smallest PU
K10 SKMIR 30	30	yellow	907304	1	25 St.

To prevent accidents and injuries you must install protective end caps.

30



### Protecting tube

	model no.	diameter (Ø) mm	length (A) mm	EAN code	Weight per 100 m kg	smallest PU
F	MI 60/6 F	60	6000	907328	308	1 x 6 m
E3	MI 60/6 E3	60	6000	908509	308	1 x 6 m

60

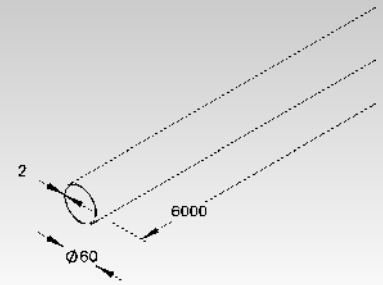

### Protective tube

slotted

	model no.	diameter (Ø) mm	length (A) mm	EAN code	Weight per 100 m kg	smallest PU
F	MIG 60/6 F	60	6000	907342	296	1 x 6 m

60

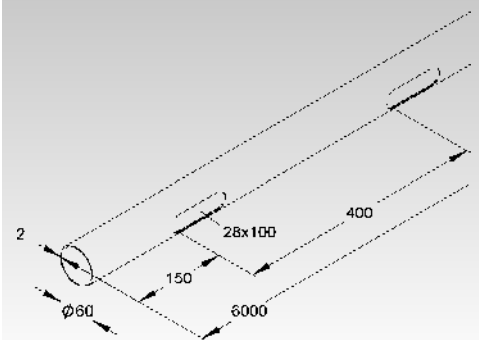

### Protecting tube downward

	model no.	diameter (Ø) mm	width B mm	width B1 mm	EAN code	Weight per 100 pce. kg	smallest PU
F	MIA 60/260 F	60	260	120	907700	62	1 St.
F	MIA 60/360 F	60	360	220	907724	77	1 St.
F	MIA 60/460 F	60	460	320	907748	93	1 St.
F	MIA 60/560 F	60	560	420	907762	108	1 St.
F	MIA 60/660 F	60	660	520	907786	123	1 St.
E3	MIA 60/260 E3	60	260	120	908769	62	1 St.

60

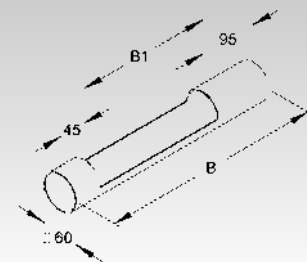

### Joiner/coupler

	model no.	diameter (Ø) mm	EAN code	Weight per 100 pce. kg	smallest PU
F	MIK 60 F	60	907465	56	1 St.
E3	MIK 60 E3	60	908608	56	1 St.

60



### Joiner/coupler

slotted

	model no.	diameter (Ø) mm	EAN code	Weight per 100 pce. kg	smallest PU
F	MIKG 60 F	60	907489	107	1 St.
E3	MIKG 60 E3	60	908622	107	1 St.

60

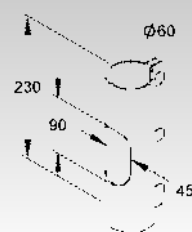

# PROTECTIVE TUBE SYSTEM

## Protecting tube bend 45°

model no.	diameter (Ø) mm	EAN code	Weight per 100 pce. kg	smallest PU
<b>F</b> MIB 6045 F	60	907366	98	1 St.
<b>E3</b> MIB 6045 E3	60	908523	98	1 St.

60

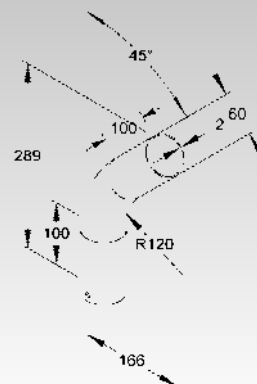

## Protecting tube bend 90°

model no.	diameter (Ø) mm	EAN code	Weight per 100 pce. kg	smallest PU
<b>F</b> MIB 6090 F	60	907380	134	1 St.
<b>E3</b> MIB 6090 E3	60	908547	134	1 St.

60

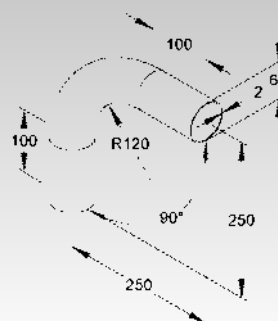

## Protecting tube bend 90°

open, small

model no.	diameter (Ø) mm	EAN code	Weight per 100 pce. kg	smallest PU
<b>F</b> MIBH 6090 F	60	907403	180	1 St.
<b>E3</b> MIBH 6090 E3	60	908561	180	1 St.

60

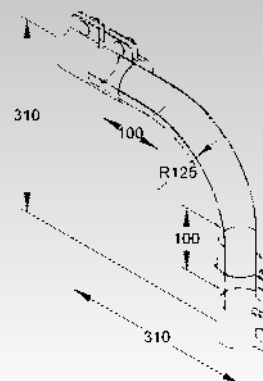

### Protecting tube bend 90°

open, big

model no.	diameter (Ø) mm	EAN code	Weight per 100 pce. kg	smallest PU
<b>F</b> MIBHG 6090 F	60	907427	240	1 St.

60

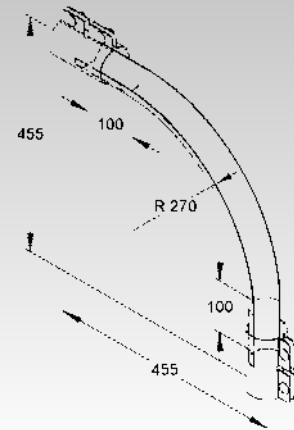

### Protecting tube tee

model no.	diameter (Ø) mm	EAN code	Weight per 100 pce. kg	smallest PU
<b>F</b> MIT 6090 F	60	907441	352	1 St.
<b>E3</b> MIT 6090 E3	60	908585	352	1 St.

60

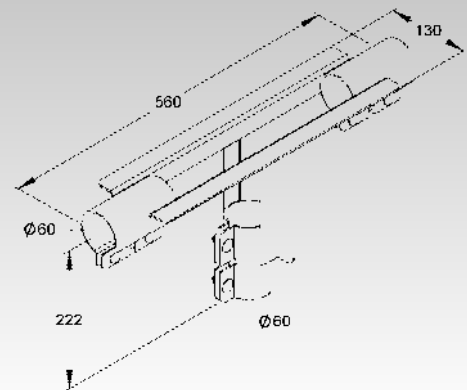

### Protecting tube floor fixing

model no.	diameter (Ø) mm	EAN code	Weight per 100 pce. kg	smallest PU
<b>F</b> MIAB 60 F	60	907502	165	1 St.
<b>E3</b> MIAB 60 E3	60	908646	165	1 St.

60

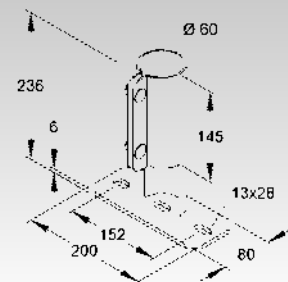



# PROTECTIVE TUBE SYSTEM

## Protecting tube floor fixing

model no.	diameter (Ø) mm	EAN code	Weight per 100 pce. kg	smallest PU
<b>F</b> MIABR 60 F	60	907526	205	1 St.
<b>E3</b> MIABR 60 E3	60	908660	205	1 St.

for mounting with tube clamp

60

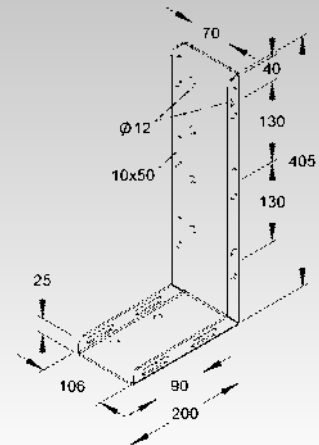

## Protecting tube floor fixing

model no.	height (H) mm	EAN code	Weight per 100 pce. kg	smallest PU
<b>F</b> MIABK 600 F	600	907922	260	1 St.
<b>E3</b> MIABK 600 E3	600	908905	260	1 St.

for mounting with joiner

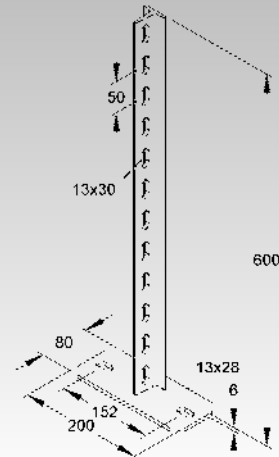

## Protecting tube support with bracket

model no.	diameter (Ø) mm	EAN code	Weight per 100 pce. kg	smallest PU
<b>F</b> MIHR 6015 F	60	907809	64	1 St.
<b>E3</b> MIHR 6015 E3	60	908783	64	1 St.

for mounting to cable tray or cable ladder

60

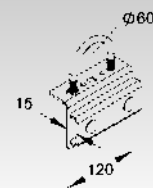

## Protecting tube support with bracket

with joiner/coupler

model no.	diameter (Ø) mm	EAN code	Weight per 100 pce. kg	smallest PU
<b>F</b> MIHK 6015 F	60	907823	181	1 St.
<b>E3</b> MIHK 6015 E3	60	908806	181	1 St.

for mounting to cable tray or cable ladder

60

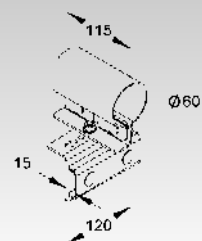

### Protecting tube support with bracket

model no.	dia- meter (Ø) mm	EAN code	Weight per 100 pce. kg	smallest PU
<b>F</b> MIHR 6030 F	60	907847	73	1 St.
<b>E3</b> MIHR 6030 E3	60	908820	73	1 St.

for mounting to wide span cable tray or wide span ladder

60

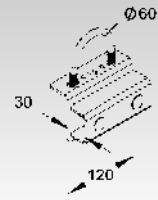

### Protecting tube support with bracket

with joiner/coupler

model no.	dia- meter (Ø) mm	EAN code	Weight per 100 pce. kg	smallest PU
<b>F</b> MIHK 6030 F	60	907861	191	1 St.
<b>E3</b> MIHK 6030 E3	60	908844	191	1 St.

for mounting to wide span cable tray or wide span ladder

60

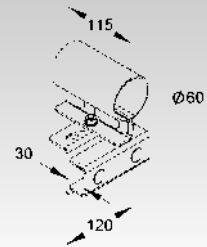

### Protecting tube support with bracket

model no.	dia- meter (Ø) mm	EAN code	Weight per 100 pce. kg	smallest PU
<b>F</b> MIHR 60 F	60	907885	97	1 St.
<b>E3</b> MIHR 60 E3	60	908868	97	1 St.

for mounting to allround cable ladder

60

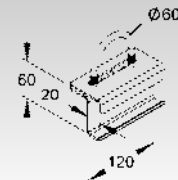

### Protecting tube support with bracket

with joiner/coupler

model no.	dia- meter (Ø) mm	EAN code	Weight per 100 pce. kg	smallest PU
<b>F</b> MIHK 60 F	60	907908	129	1 St.
<b>E3</b> MIHK 60 E3	60	908882	129	1 St.

for mounting to allround cable ladder

60

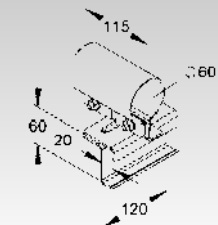

### Protecting tube mounting plate

incl. 1 endless screw clamp

model no.	height (H) mm	dia- meter (Ø) mm	EAN code	Weight per 100 pce. kg	smallest PU
<b>F</b> MIMPA 60/175 F	175	60	907540	69	1 St.
<b>E3</b> MIMPA 60/175E3	175	60	908684	69	1 St.

60

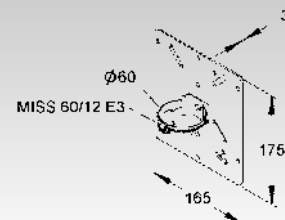

# PROTECTIVE TUBE SYSTEM

## Protecting tube mounting plate

incl. 2 endless screw clamps

model no.	height (H) mm	dia- meter (Ø) mm	EAN code	Weight per 100 pce. kg	smallest PU
<b>F</b> MIMPA 60/260 F	260	60	907564	113	1 St.
<b>E3</b> MIMPA 60/260E3	260	60	908707	113	1 St.

60

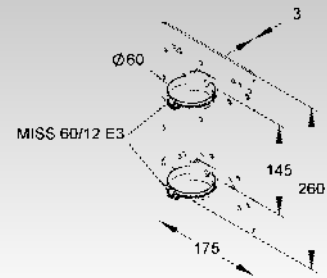

## Protecting tube mounting plate

incl. 2 endless screw clamps

model no.	height (H) mm	dia- meter (Ø) mm	EAN code	Weight per 100 pce. kg	smallest PU
<b>F</b> MIMPA 60/380 F	380	60	907588	257	1 St.
<b>E3</b> MIMPA 60/380E3	380	60	908721	257	1 St.

60

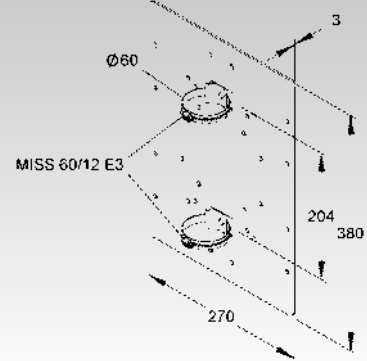

## Mounting support closed

model no.	length (A) mm	dia- meter (Ø) mm	EAN code	Weight per 100 pce. kg	smallest PU
<b>F</b> MIMTA 60/325 F	325	60	907601	181	1 St.
<b>F</b> MIMTA 60/425 F	425	60	907625	223	1 St.
<b>F</b> MIMTA 60/525 F	525	60	907649	265	1 St.
<b>F</b> MIMTA 60/625 F	625	60	907663	306	1 St.
<b>E3</b> MIMTA 60/325E3	325	60	908745	181	1 St.

60

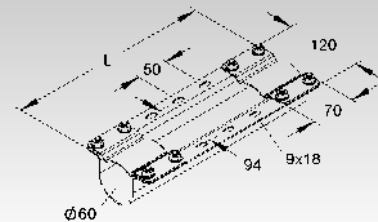

## Mounting support closed

model no.	length (A) mm	dia- meter (Ø) mm	EAN code	Weight per 100 pce. kg	smallest PU
<b>F</b> MIMTB 60/360 F	360	60	907687	230	1 St.
<b>E3</b> MIMTB 60/360E3	360	60	908752	230	1 St.

60

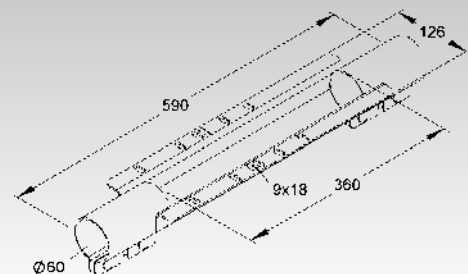

## Protecting tube clamp

model no.	dia- meter (Ø) mm	EAN code	Weight per 100 pce. kg	smallest PU
<b>F</b> MIRS 60 F	60	907946	22	20 St.
<b>E3</b> MIRS 60 E3	60	908929	22	20 St.

60

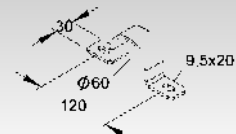

## Drill distance clamp

heavy

model no.	diameter (Ø) mm	EAN code	Weight per 100 pce. kg	smallest PU
<b>F</b> SASS 60 F	60	907960	31	1 St.

60



## Tube clamp

model no.	diameter (Ø) mm	EAN code	Weight per 100 pce. kg	smallest PU
<b>F</b> MIRB 60 F	60	907984	13	20 St.
<b>E3</b> MIRB 60 E3	60	908943	13	20 St.

60



## Protecting tube anchor clamp

incl. 1 endless screwed clamp

model no.	diameter (Ø) mm	EAN code	Weight per 100 pce. kg	smallest PU
<b>F</b> MIMS 60 F	60	908004	8	1 St.
<b>E3</b> MIMS 60 E3	60	908967	8	1 St.

60

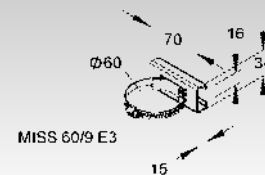

## Endless screw clamp

model no.	diameter (Ø) mm	height (H) mm	EAN code	Weight per 100 pce. kg	smallest PU
<b>E3</b> MISS 60/9 E3	60	9	908981	11	50 St.
<b>E3</b> MISS 60/12 E3	60	12	926503	15	25 St.

60



## Protective endcap, soft plastic

model no.	diameter (Ø) mm	color	EAN code	Weight per 100 pce. kg	smallest PU
<b>K10</b> SKMI 60	60	yellow	908028	2	25 St.

To prevent accidents and injuries you must install protective end caps.

60

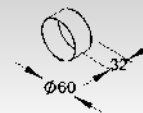

## Protective endring, soft plastic

model no.	diameter (Ø) mm	color	EAN code	Weight per 100 pce. kg	smallest PU
<b>K10</b> SKMIR 60	60	yellow	908042	2	25 St.

To prevent accidents and injuries you must install protective end caps.

60

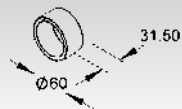

## Edge Protection Strip

with steel or stainless steel insert

model no.	color	EAN code	Weight per 100 m kg	smallest PU
<b>K10</b> RKBA 10	black	206100	15	1 x 10 m
<b>K10</b> RKBA 10 E4	black	729050	15	1 x 10 m

for protecting cut edges with a material thickness from 0,75 mm up to 4 mm

To prevent accidents and injuries you must install edge protection strip!  
temperature range -25°C to +70°C

60

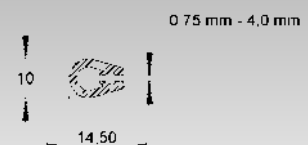

# PROTECTIVE TUBE SYSTEM

## Warning sign

self adhesive

model no.	height (H) mm	width B mm	EAN code	Weight per 100 pce. kg	smallest PU
<b>MIWZ 105</b>	105	52	922369		1 St.



## Description sign

model no.	EAN code	Weight per 100 pce. kg	smallest PU
<b>E3 MIKS 80X37 E3</b>	922963	2,7	20 St.

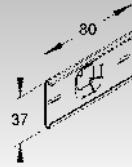

---

# NOTIZEN

